

4.0A GLASS PASSIVATED SINGLE-PHASE BRIDGE RECTIFIER

Features

- Glass Passivated Die Construction
- Low Forward Voltage Drop
- High Current Capability
- High Reliability
- High Surge Current Capability
- Ideal for Printed Circuit Boards
-  Recognized File # E157705

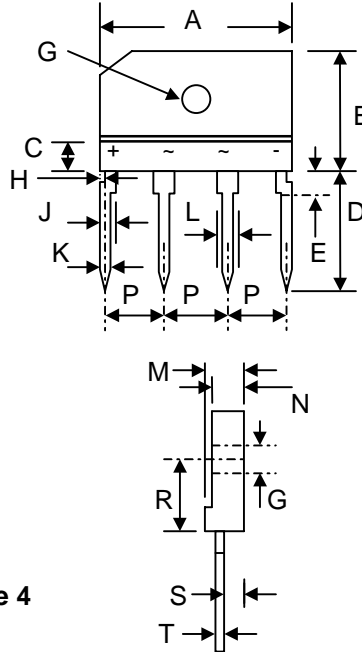

KBJ-4		
Dim	Min	Max
A	24.7	25.3
B	14.7	15.3
C	—	4.0
D	17.0	18.0
E	3.3	3.7
G	3.1Ø	3.6Ø
H	1.05	1.45
J	1.7	2.1
K	0.9	1.1
L	1.8	2.2
M	4.4	4.8
N	3.4	3.8
P	7.3	7.7
R	9.3	9.7
S	2.5	2.9
T	0.6	0.8
All Dimensions in mm		

Mechanical Data

- Case: KBJ-4, Molded Plastic
- Terminals: Plated Leads Solderable per MIL-STD-202, Method 208
- Polarity: As Marked on Body
- Weight: 6.0 grams (approx.)
- Mounting Position: Any
- Mounting Torque: 10 cm·kg (8.8 in·lbs) Max.
- **Lead Free: For RoHS / Lead Free Version, Add "-LF" Suffix to Part Number, See Page 4**

Maximum Ratings and Electrical Characteristics @ $T_A=25^\circ\text{C}$ unless otherwise specified

Single Phase, half wave, 60Hz, resistive or inductive load.
For capacitive load, derate current by 20%.

Characteristic	Symbol	GBJ4A	GBJ4B	GBJ4D	GBJ4G	GBJ4J	GBJ4K	GBJ4M	Unit
Peak Repetitive Reverse Voltage	V_{RRM}								
Working Peak Reverse Voltage	V_{RWM}	50	100	200	400	600	800	1000	V
DC Blocking Voltage	V_R								
RMS Reverse Voltage	$V_{R(RMS)}$	35	70	140	280	420	560	700	V
Average Rectified Output Current @ $T_C = 115^\circ\text{C}$ (Note 1)	I_O	4.0							A
Non-Repetitive Peak Forward Surge Current 8.3ms Single half sine-wave superimposed on rated load (JEDEC Method)	I_{FSM}	150							A
Forward Voltage per diode @ $I_F = 2.0\text{A}$	V_{FM}	1.0							V
Peak Reverse Current @ $T_A = 25^\circ\text{C}$ At Rated DC Blocking Voltage @ $T_A = 125^\circ\text{C}$	I_R	10 250							μA
Typical Thermal Resistance per leg (Note 2)	$R_{\theta JA}$	30							$^\circ\text{C/W}$
Typical Thermal Resistance per leg (Note 1)	$R_{\theta JC}$	5.5							$^\circ\text{C/W}$
Operating and Storage Temperature Range	T_j, T_{STG}	-55 to +150							$^\circ\text{C}$

Note: 1. Device mounted on 75 x 75 x 1.6mm thick Al plate heatsink.
2. Device mounted on P.C.B. without heatsink.

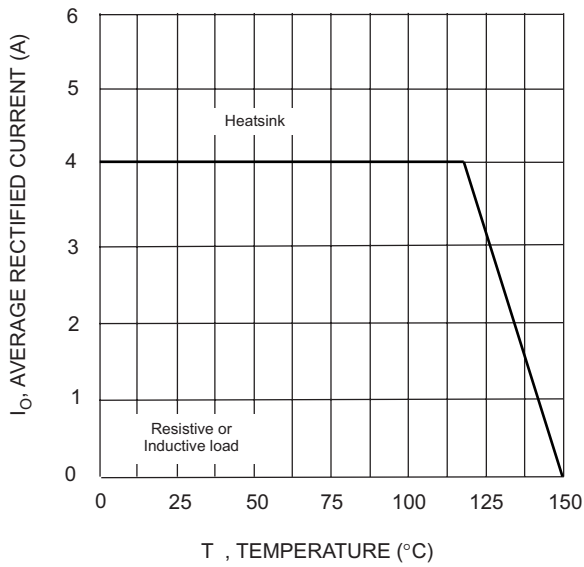

Fig. 1 Forward Current Derating Curve

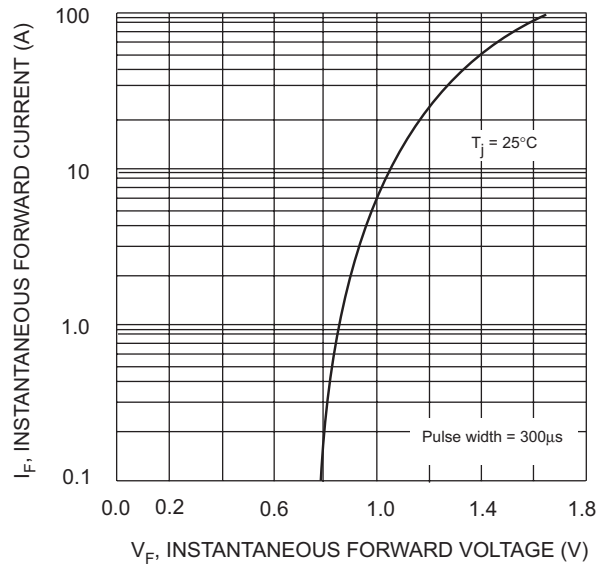

Fig. 2 Typical Fwd Characteristics, per element

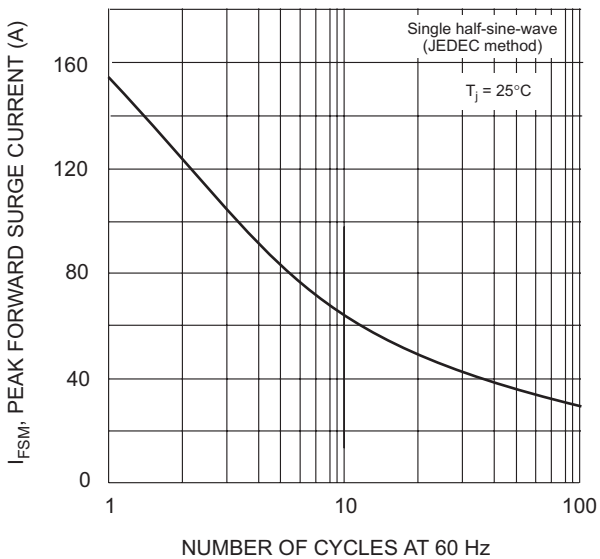

Fig. 3 Maximum Non-Repetitive Surge Current

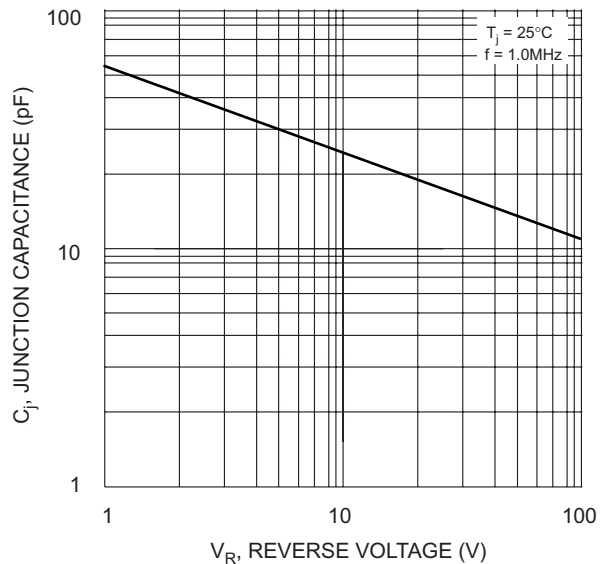
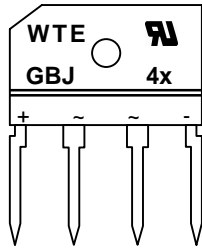

Fig. 4 Typical Junction Capacitance

MARKING INFORMATION



WTE = Manufacturer's Logo
 GBJ4x = Device Number
 x = A, B, D, G, J, K or M
 Polarity = As Marked on Body

PACKAGING INFORMATION

BULK

Tube Size L x W x H (mm)	Quantity (PCS)	Inner Box Size L x W x H (mm)	Quantity (PCS)	Carton Size L x W x H (mm)	Quantity (PCS)	Approx. Gross Weight (KG)
525 x 35 x 7	20	542 x 135 x 135	1,000	557 x 270 x 270	4,000	30.0

Note: 1. Anti-static tube, water clear color.

ORDERING INFORMATION

Product No.	Package Type	Shipping Quantity
GBJ4A	SIL Bridge	20 Units/Tube
GBJ4B	SIL Bridge	20 Units/Tube
GBJ4D	SIL Bridge	20 Units/Tube
GBJ4G	SIL Bridge	20 Units/Tube
GBJ4J	SIL Bridge	20 Units/Tube
GBJ4K	SIL Bridge	20 Units/Tube
GBJ4M	SIL Bridge	20 Units/Tube

1. Shipping quantity given is for minimum packing quantity only. For minimum order quantity, please consult the Sales Department.
2. **To order Lead Free version (with Lead Free finish), add "-LF" suffix to part number above. For example, GBJ4A-LF.**

Won-Top Electronics Co., Ltd (WTE) has checked all information carefully and believes it to be correct and accurate. However, WTE cannot assume any responsibility for inaccuracies. Furthermore, this information does not give the purchaser of semiconductor devices any license under patent rights to manufacturer. WTE reserves the right to change any or all information herein without further notice.

WARNING: DO NOT USE IN LIFE SUPPORT EQUIPMENT. WTE power semiconductor products are not authorized for use as critical components in life support devices or systems without the express written approval.

Won-Top Electronics Co., Ltd.

No. 44 Yu Kang North 3rd Road, Chine Chen Dist., Kaohsiung, Taiwan

Phone: 886-7-822-5408 or 886-7-822-5410

Fax: 886-7-822-5417

Email: sales@wontop.com

Internet: <http://www.wontop.com>

We power your everyday.